

A.S.P. Electro-Technology Ltd

Tel: +44 (0) 1455 635796
Fax: +44 (0) 1455 610851

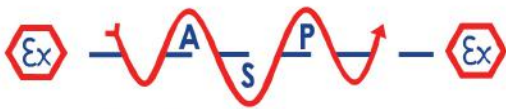
sales@asp-electro-tech.com
www.asp-electro-tech.com

EXEL-L

- Complete with high efficiency LED tubes
- Quick access to the internal electrical equipment
- Double locking system operated by hexagonal-head tool
- Zone 1, 2, 21, 22

'Ex op Is'
safe optical radiation



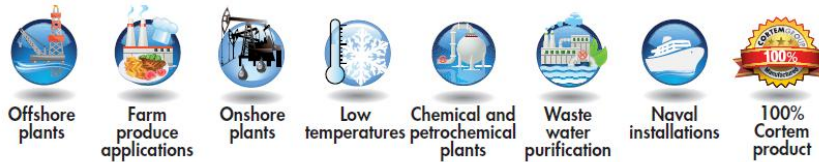


EXEL-L series lighting fixture with Cortem resin-bonded LED tubes

EXEL-L series increased safety lighting fixtures for LEDs resin-bonded tubes are suitable to be installed in hazardous areas where a high degree of protection and resistance against corrosion is required. EXEL-L series is GRP made and features the 'Ex de mb op is' according to the safe optical radiation standard. It's equipped with LED tubes sealed in a transparent resin. The LED tubes are manufactured by Cortem and they are certified and supplied along with the lighting fixture. The through wiring double ended makes installation on field easier and faster. The transparent cover is clipped into place on both sides of the fixture body with 8 clips on the EXEL-215L model and 14 clips on the EXEL-230L unit. This ensures excellent protection against dust and water over time. A safety switch housed inside the lighting fixture cuts off automatically the power supply when the lighting fixture is opened for the LED tubes and/or electrical component replacement. The EXEL-L series provides four models fitted with a Ni-Cd battery with electronic inverter for use in emergency operation. Thanks to the use of LED technology applied also on the emergency models, the operating time and the energy saving are considerably greater.

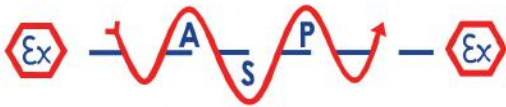
A red LED warning light comes off if the battery needs to be replaced due to a short circuit or if the battery itself is dead.

Application sectors:



CERTIFICATION DATA

Classification:	Group II	Category 2GD		
Installation: EN 60079.14	zone 1 - zone 2 (Gas)	zone 21 - zone 22 (Dust)		
Marking:	CE 0722 Ex II 2GD - Ex de mb op is IIC T6/T5 Gb - Ex tb IIC T49°C/T64°C Db IP66			
Certification:	ATEX CML 15 ATEX 3188			
	IECEX CML 15.0044	All IEC Ex, TR CU and INMETRO certification data can be downloaded at www.cortemgroup.com		
	TR CU AVAILABLE			
	INMETRO DNV 12.0055 X			
Standards:	CENELEC EN60079-0: 2012, EN60079-1: 2007, EN60079-7: 2007, EN60079-18: 2015, EN60079-28: 2015, EN60079-31: 2014 and EUROPEAN DIRECTIVE 2014/34/UE. IEC60079-0: 2011, IEC60079-1: 2007-04, IEC60079-18: 2014, IEC60079-28: 2015, IEC60079-31: 2013, IEC60079-7: 2006-07			
Class temperature:	85°C (T6)	100°C (T5)		
Ambient temperature:	-40°C +40°C (T6)	-40°C +55°C (T5)	With emergency -20°C +50°C (T5)	
Degree of protection:	IP66			



EXEL-L series lighting fixture with Cortem resin-bonded LED tubes



ORIGINAL PRODUCT

MECHANICAL FEATURES

Body:	Black shock and UV resistant fibreglass reinforced anti-static polyester resin
Diffuser:	Transparent polycarbonate, shock and UV resistant
Protected opening system:	Sliding system operated by a hexagonal-head tool (for safety reasons, the fixture can not be opened without the tool)
Gasket:	Acid/hydrocarbon resistant expanded silicone
Reclining frame:	Aluminium and stainless steel
Inner fixed frame:	Extruded aluminium
Bolts and screws:	Stainless steel
Entries:	4 x Ø25.5 entries (suitable for ISO M25x1.5 threads). Lighting fixture kit contains 3 model PLG21LXE7 plugs and 2 model UNI2LXE7DS cable glands for non-armoured cable
Mounting:	Nickel plated brass inserts with 2 x M8 holes

ELECTRICAL FEATURES

Ballast:	Electronic
Rated voltage:	110/277 Vac dc (EXEL-215L) 220/240 Vac dc (EXEL-230L)
Rated frequency:	50/60 Hz
Connection:	Directly to terminal board L, N, Pe section 4 mm ² terminal board with jumpers suitable for through wiring double ended
Emergency unit:	Electronic inverter 110/240 Vac 50/60 Hz, 110-270 Vdc. Batteries Ni/Cd, 4 Ah o 7 Ah, 6V
Wiring:	Silicone rubber cables with glass braid insulation for high temperatures

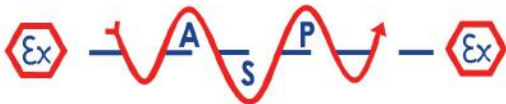
ACCESSORIES AVAILABLE / SPECIAL REQUESTS

Installation brackets

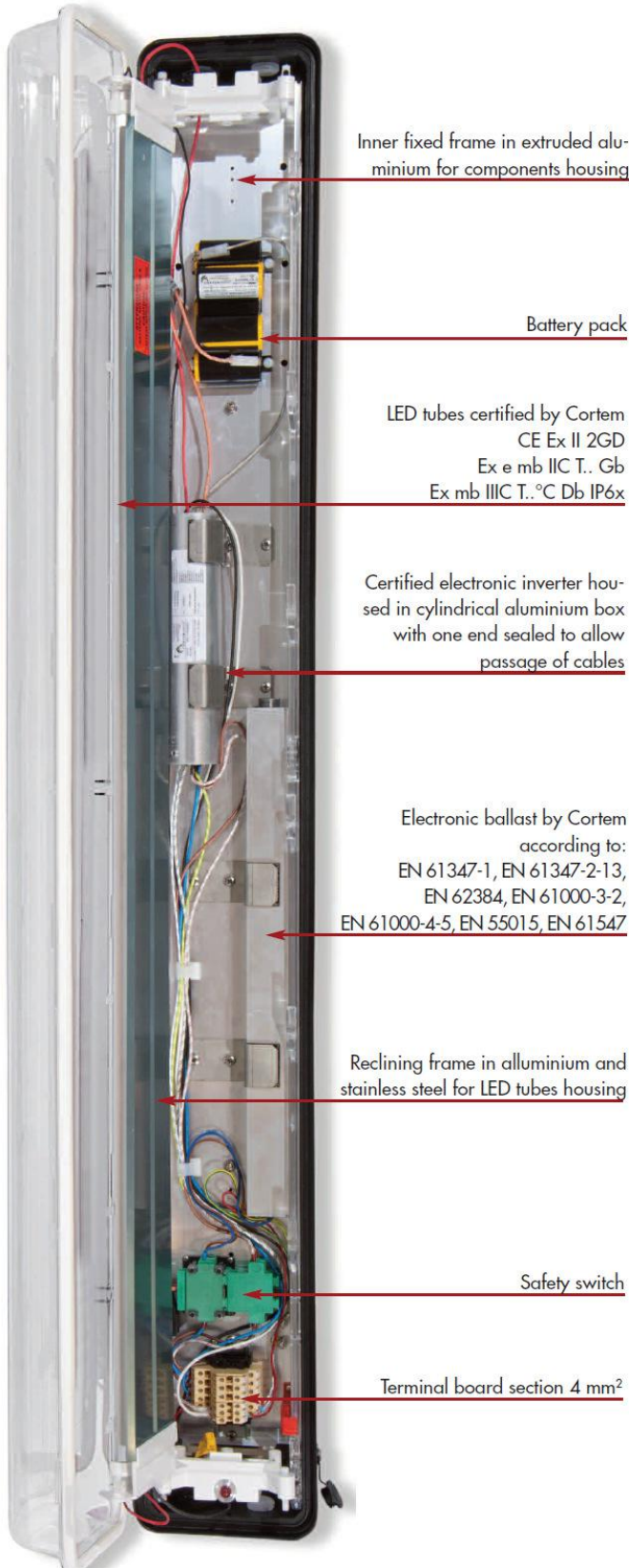
Grey polyester resin body (code EXEL-215L**G**)

Cable entry: 4 x Ø20.5 holes. Lighting fixture kit contains 3 model PLG11LXE7 plugs and 2 model UNI1LXE7 cable glands for non-armoured cable (code EXEL-215L/**20**)

Earthing continuity plates for metal cable glands



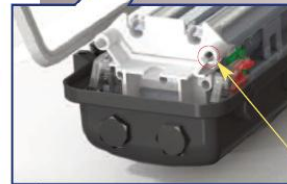
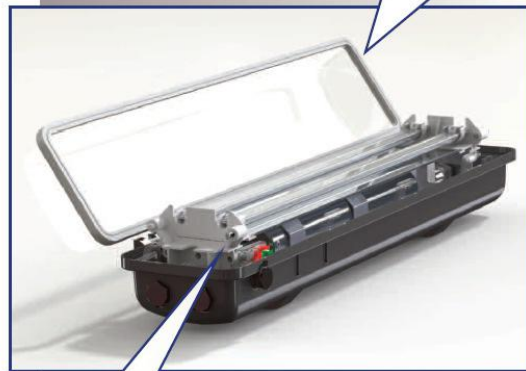
EXEL-L series lighting fixture with Cortem resin-bonded LED tubes



Quick access

Thanks to the new reclining frame on which the LED tubes are housed, it's possible an easy access to the inside part of the lighting fixture. This system simplifies the maintenance and any interventions on the electrical part by the operator, ensuring greater safety and quick service.

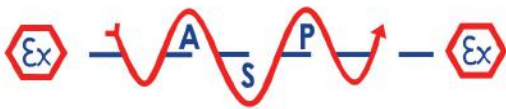
180° opening of the transparent diffuser by means of a hexagonal-head tool



Manually loosening the two screws, you can recline entirely the frame and access directly to the electrical components.




Internal electrical components easily accessible by the operator for a rapid replacement in case of fault.
Wiring is carried out with safety and without that detached parts of the frame obstacle maintenance operations.




EXEL-L series lighting fixture with Cortem resin-bonded LED tubes


Normal working

Code	Dimensions mm				Watt	LED tubes n°	Power supply	Weight Kg	
	A	A1	B	C					
EXEL-215L	785	420	185	155	29	2	110-277 Vac dc 50/60Hz	4,9	196x155x820
EXEL-230L	1370	720	185	155	56	2	220-240Vac dc 50/60Hz	9,2	196x155x1400

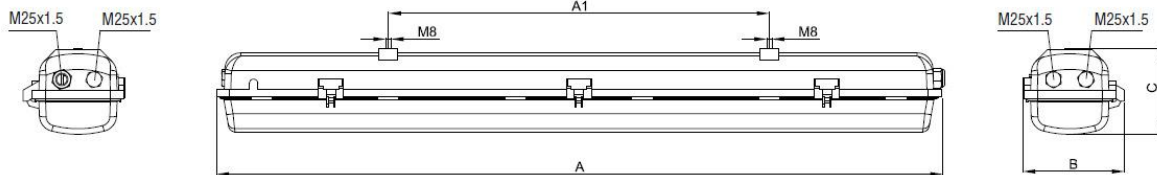
Normal + emergency working

Code	Dimensions mm				Operating type	LED tubes n°	Power supply	Watt	Discharge time in minutes	Weight Kg	
	A	A1	B	C							
EXEL-215LEF4	785	420	185	155	normal + emergency	2	220-240Vac 50/60Hz	29	180'	7,2	196x155x820
EXEL-230LEF4	1370	720	185	155	normal + emergency	2	220-240Vac 50/60Hz	56	120'	10,1	196x155x1400
EXEL-215LEF7	785	420	185	155	normal + emergency	2	220-240Vac 50/60Hz	29	240'	7,2	196x155x820
EXEL-230LEF7	1370	720	185	155	normal + emergency	2	220-240Vac 50/60Hz	56	240'	10,1	196x155x1400

Only emergency working

Code	Dimensions mm				Operating type	LED tubes n°	Power supply	Discharge time in minutes	Weight Kg	
	A	A1	B	C						
EXEL-115LEE4	785	420	185	155	only emergency	1	230Vac ±10% 50/60Hz	180'	7,2	196x155x820
EXEL-130LEE4	1370	720	185	155	only emergency	1	230Vac ±10% 50/60Hz	120'	10,1	196x155x1400
EXEL-115LEE7	785	420	185	155	only emergency	1	230Vac ±10% 50/60Hz	240'	7,2	196x155x820
EXEL-130LEE7	1370	720	185	155	only emergency	1	230Vac ±10% 50/60Hz	240'	10,1	196x155x1400

DIMENSIONAL DRAWING



DON'T FORGET TO ORDER THE ACCESSORIES







Example: Type of lighting fixture
EXEL-215L

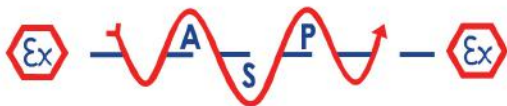
+

Installation bracket
G-0480

+ other ...see key

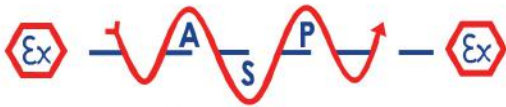


ILLUSTRATION	DESCRIPTION	MODEL	FEATURES	CODE	KEY
	Tige	Length: 250 mm	Material: stainless steel	BRF8MIN/250	 
	Eyebolt		Material: galvanised steel	GOF-8	 

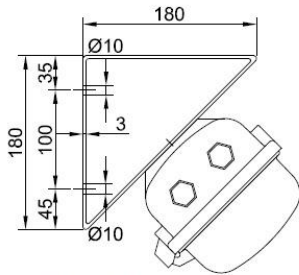


EXEL-L series lighting fixture with Cortem resin-bonded LED tubes

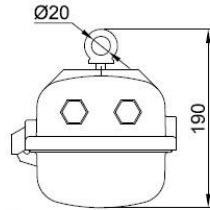
ILLUSTRATION	DESCRIPTION	MODEL	FEATURES	CODE	KEY
	Type U bracket complete with screws		Material: bracket: galvanised steel screws: stainless steel	G-0609	
	Type V bracket complete with screws		Material: bracket: galvanised steel screws: stainless steel	G-0610	
	Type D bracket complete with screws		Material: bracket: galvanised steel screws: stainless steel	G-0611	
	Type P bracket		Material: bracket: galvanised steel screws: stainless steel	G-0480	
	Earthing continuity plates for metal cable glands	Holes: M20x1.5	Material: brass	B-479	
		Holes: M25x1.5		B-479/1	
	LED resin-bonded	EXEL-215L	LED tubes exec. Ex mb	B215-0300	
		EXEL-230L		B230-0300	
	Transparent diffuser	EXEL-215L	Material: polycarbonate	B18-363	
		EXEL-230L		B36-363	
	Non-armoured cable gland complete with rubbers, seal and lock nut	ISO M25x1,5	Ex e II IP 66/67 (std. range cable 10-18)	UNI2LXE7DS	
	Plug with seal and lock nut	ISO M25x1,5	Ex e II IP 66/67	PLG2ILXE7	
	Hexagonal-head tool	Hexagon 10		CLAFT10	
	Electronic inverter		110-240 Vac, 110-270 Vdc	EI-30L	
	Battery pack		4 Ah 6V NiCd	G-0309B	
			7 Ah 6V NiCd	G-0309	
	Electronic ballast	EXEL-215L	110/277 Vac 50/60 Hz 110/277 Vdc	EB215L	
	Electronic ballast	EXEL-230L	220/240 Vac 50/60 Hz 220/240 Vdc	EBL4040-2	



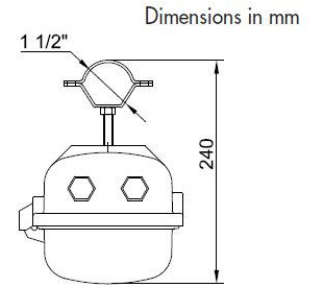
EXEL-L series lighting fixture with Cortem resin-bonded LED tubes



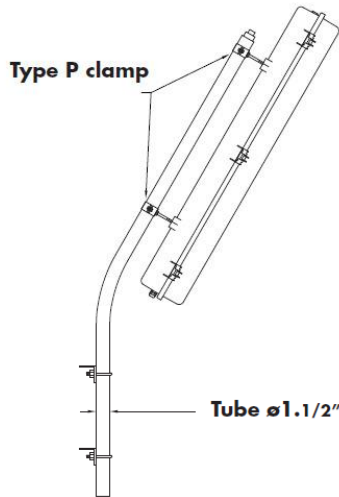
45° angle mounting
TYPE "D"



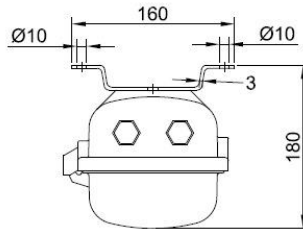
Pendant mounting
with eyebolt TYPE "O"



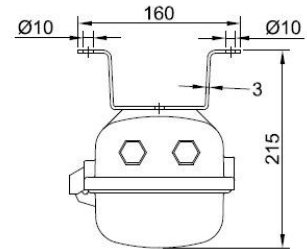
Mounting using 1.1/2"
metal clamps TYPE "P"



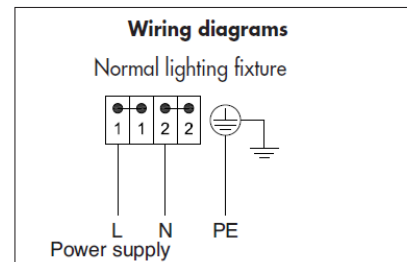
Standard pole mounting



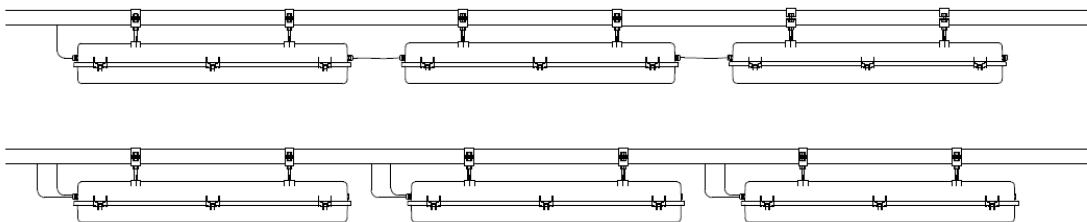
Low ceiling mounting with
clamp TYPE "U"

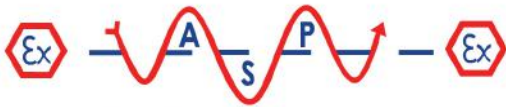


High ceiling mounting with
clamp TYPE "V"



Connections can be made on either side of the fixture body
for simple, fast installation

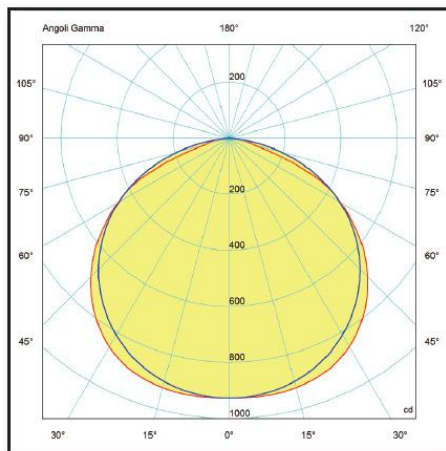




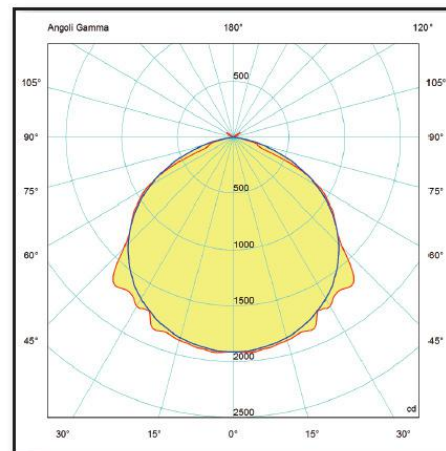
EXEL-L series lighting fixture with Cortem resin-bonded LED tubes

Electrical features	EXEL-215L	EXEL-230L
Power supply:	220-240 Vac	220-240 Vac
Rated frequency:	50-60 Hz	50-60 Hz
Power consumption:	29 W	56 W
Connection:	Direct connection to terminal board L, N, Pe. Section 4mm ² , suitable for loop-in/loop-out	
Power factor:	>0,93*	>0,98*
Rated current:	146 mA*	265 mA*
EMC (electromagnetic compatibility):	EN 55015, EN 61547, IEC 61000-3-2, IEC 61000-3-3	
THD (total harmonic distortion):	<4% 230 Vac, 50 Hz	
Over-voltage protection:	4 kV	4 kV
Driver performances:	Over-Voltage protection, Over-Current protection, Short-Circuit protection	
Photometric features		
LED:	Resin-bonded LED tubes	
Viewing angle:	120°	120°
Colour temperature:	5000 K	5000 K
CRI:	80	80
Instant Restrike:	SI	SI
Lumen:	2850 lm	5637 lm
Maximum light intensity:	927 cd	1920 cd
Overall efficiency:	98 lm/W	100 lm/W

* Test at 220Vac



EXEL-215L



EXEL-230L

— = plane 90270
— = plane 0180